

# SunCentric Surface Pump



IMPROPER INSTALLATION WILL DAMAGE THE PUMP AND VOID THE WARRANTY

PLEASE READ AND SAVE THIS MANUAL

RECORD MODEL # \_\_\_\_\_ - \_\_\_\_\_ SERIAL # \_\_\_\_\_

This manual is for the Dankoff Solar SunCentric Surface Pump for water lift and distribution.



# Contents

- 1. WARNINGS ..... 3
- 2. INSTALLATION REQUIREMENTS..... 4
- 3. PLUMBING SYSTEM DESIGN..... 5
- 4. ELECTRICAL WIRING ..... 9
  - 4.1 WIRE SIZING ..... 9
  - 4.2 FUSE OR CIRCUIT BREAKER PROTECTION..... 10
  - 4.3 GROUND AND LIGHTNING PROTECTION ..... 10
- 5. SOLAR ARRAY WIRING (FOR PV-DIRECT SYSTEMS)..... 12
- 6. POWER CONTROL FOR PV-DIRECT (NON-BATTERY) OPERATION..... 14
- 7. BATTERY SYSTEMS ..... 15
- 8. TROUBLESHOOTING ..... 17
- 9. MAINTENANCE ..... 20
- 10. PUMP REPAIRS ..... 21
- 11. NOTES TO INSTALLERS ..... 23



# 1. WARNINGS

Please review the following warnings. These are listed for both personal safety and the safety of the products. Disregarding or ignoring these warnings can result in **SERIOUS INJURY** and/or **VOID THE WARRANTY**. If this system is being installed without a licensed pump installer, an electrician or knowledge of electrical circuits is **HIGHLY** recommended.

If any questions or concerns regarding these warnings should arise, please contact your local Dankoff Solar dealer or Dankoff Solar Technical Support at 1(505) 395-2491. Dankoff Solar Pumps and/or its parent company, Solar Power & Pump Co, is **NOT LIABLE** for any **DAMAGE** or **INJURY**.

- The system should be installed and serviced by qualified personnel only. All electrical codes should be observed. Make **ABSOLUTELY CERTAIN** all power sources are disconnected prior to wiring.
- Extreme heat can damage the pump. Protect the pump from sunlight or other heat sources.
- Install proper system grounding for safety and lightning protection. Proper grounding can significantly reduce the chance of extreme damage. See Section 4.4 Grounding and Lightning Protection
- Under-sizing the wires or failing to install a fuse or circuit breaker can cause a Fire Hazard and cause damage to the motor. Follow all guidelines in Section 4
- Do not touch solar panel or pump wires together to test for a spark.
- Do not run the pump dry.
- The use of a filter is required. For details, see Section 2 Installation Requirements

## 2. INSTALLATION REQUIREMENTS

### **Non-submersible pumps**

Do not submerge pump or motor in water. Do not allow water to drip on the motor. Protect the pump and motor from sunshine. If the pump is installed outdoors, supply weather protection, such as a sheet-metal shield, shed or well house.

### **Filtration requirements**

SunCentric Pumps are somewhat dirt tolerant and can be run from many clean water sources without filtration. However, if pulling from a reservoir where debris (pebbles/rocks) may be present, a high flow spin down filter should be used on the intake line. A Dankoff Solar Fine Intake Strainer Foot Valve (PN – 11044) is recommended for these conditions.

### **Pump must not run dry**

Water is the lubricant for the pump. If the pump runs completely dry, it will overheat and fail. If pumping from a tank, cistern or any water source that can run low accidentally, a float switch must be used.

A float switch (PN – 11004, pump down switch) placed in the supply tank closes when the tank water supply is at a high level. When the water level drops to a low level, the switch will open and remove power from the pump motor.

### **Shelter is required**

Your motor may overheat if exposed to very hot sun. Rain exposure will greatly reduce bearing and brush life and will make the motor difficult to repair. If the pump is to be used outdoors, it must be covered. The pump shelter must have some opening to allow circulation of air from the outside to prevent overheating of the motor.

Here are some suggestions for outdoor shelters: a curved piece of sheet metal with open ends (the cover should be twice as long as the pump); a metal barrel cut in half the long way and placed over the pump; any weatherproof box inverted over the pump; a dog house set it over the pump with the pipes passing through the doorway.

### 3. PLUMBING SYSTEM DESIGN

## Water Pipe Sizing Chart

Friction Loss in Plastic Pipe with Standard Inside Diameter (SIDR)

THIS CHART APPLIES ONLY TO: PVC pipe, Schedule 40 (160 PSI) and to PE (polyethylene) pipe with SIDR designation (most common 100 PSI black pipe)

HEAD LOSS in VERTICAL FEET per HUNDRED FEET of pipe  
or VERTICAL METERS per HUNDRED METERS of pipe

Nominal Pipe Diameter (Inches)

FLOW RATE		Nominal Pipe Diameter (Inches)										
		1/2 *	3/4	1	1 1/4	1 1/2	2	2 1/2	3	4	5	6
GPM	LPM	.662	.82	1.05	1.38	1.61	2.07	2.47	3.07	4.03	5.05	6.06
		actual Inside Diameter (inches)										
1	3.8	1.13	0.14	0.05	0.02	.	.	.	.	.	.	.
2	7.6	4.16	0.35	0.14	0.05	0.02	.	.	.	.	.	.
3	11	8.55	2.19	0.32	0.09	0.05	.	.	.	.	.	.
4	15	14.8	3.70	0.53	0.16	0.09	0.02	.	.	.	.	.
5	19	22.2	5.78	0.81	0.25	0.12	0.04	.	.	.	.	.
6	23	31.0	7.85	1.00	0.35	0.18	0.07	0.02	.	.	.	.
7	27	.	10.6	1.52	0.46	0.23	0.08	0.03	.	.	.	.
8	30	.	13.4	1.94	0.58	0.30	0.09	0.05	.	.	.	.
9	34	.	16.9	2.43	0.72	0.37	0.12	0.06	.	.	.	.
10	38	.	20.3	2.93	0.88	0.46	0.16	0.07	0.02	.	.	.
11	42	.	24.3	3.51	1.04	0.53	0.18	0.08	0.03	.	.	.
12	46	.	28.6	4.11	1.22	0.65	0.21	0.09	0.04	.	.	.
14	53	.	.	5.47	1.64	0.85	0.28	0.12	0.05	.	.	.
16	61	.	.	7.02	2.10	1.09	0.37	0.14	0.06	.	.	.
18	68	.	.	8.73	2.61	1.34	0.46	0.18	0.07	.	.	.
20	76	.	.	10.6	3.16	1.64	0.55	0.21	0.08	0.02	.	.
22	83	.	.	13.3	3.79	1.96	0.67	0.25	0.09	0.03	.	.
24	91	.	.	14.9	4.44	2.31	0.79	0.30	0.11	0.04	.	.
26	99	.	.	.	5.15	2.66	0.90	0.35	0.14	0.05	.	.
28	106	.	.	.	5.91	3.05	1.04	0.42	0.16	0.05	.	.
30	114	.	.	.	6.72	3.46	1.18	0.46	0.18	0.06	.	.
35	133	.	.	.	8.94	4.62	1.57	0.62	0.23	0.07	.	.
40	152	.	.	.	11.0	5.91	1.99	0.79	0.30	0.09	0.02	.
45	171	.	.	.	14.2	7.37	2.49	0.97	0.37	0.12	0.04	.
50	190	.	.	.	17.3	8.96	3.03	1.20	0.46	0.14	0.05	.
55	208	.	.	.	.	10.7	3.60	1.43	0.55	0.16	0.06	.
60	227	.	.	.	.	12.5	4.23	1.66	0.65	0.18	0.07	0.02
65	246	.	.	.	.	14.5	4.90	1.94	0.74	0.22	0.08	0.03
70	265	.	.	.	.	16.7	5.64	2.22	0.85	0.25	0.09	0.04
75	284	.	.	.	.	19.0	6.40	2.52	0.97	0.28	0.10	0.05
80	303	.	.	.	.	.	7.21	2.84	1.09	0.32	0.12	0.06
85	322	.	.	.	.	.	8.06	3.19	1.22	0.37	0.13	0.07
90	341	.	.	.	.	.	8.96	3.53	1.36	0.39	0.14	0.08
95	360	.	.	.	.	.	9.91	3.90	1.50	0.44	0.16	0.09
100	379	.	.	.	.	.	10.9	4.30	1.66	0.49	0.18	0.12
150	569	.	.	.	.	.	23.1	9.10	3.51	1.04	0.37	0.16
200	758	.	.	.	.	.	.	15.5	5.98	1.76	0.62	0.28

NOTE: Shaded values are at velocities over 5 feet per second and should be selected with caution.

\* NOTE: 1/2" data applies to PE pipe only. PVC has smaller ID of .612"



Figure 3-2: Buried Plastic Tank

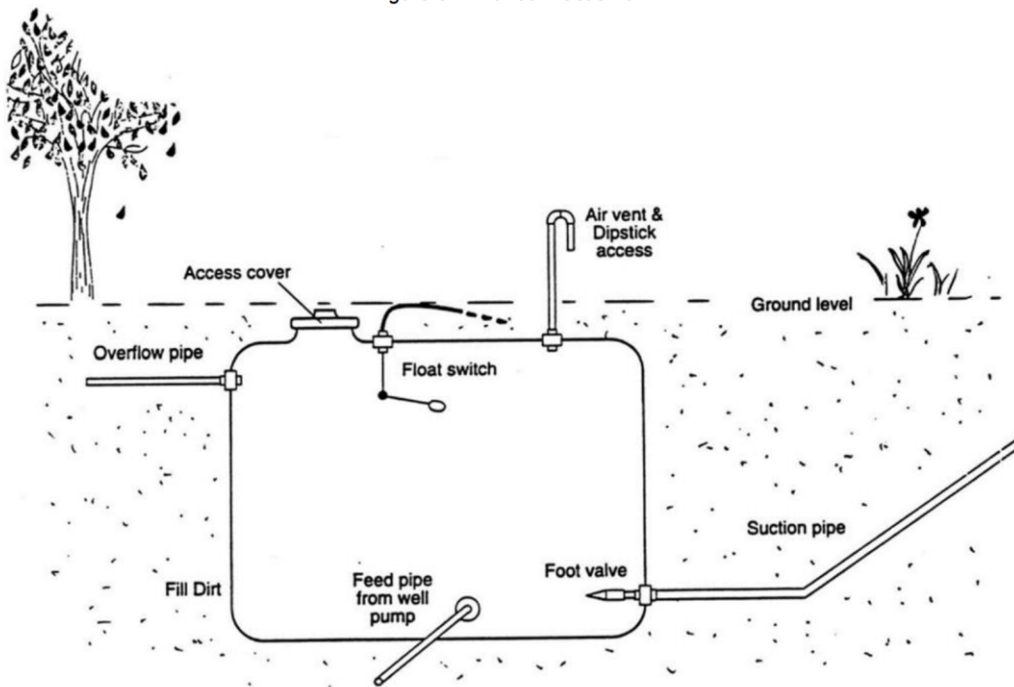

*It is preferable to place the pump lower than the water level in the tank. Note the upward rise of the suction pipe, the high position of the priming plug, and the horizontal position of the filter. Taking these measures help to prevent air entrapment that restricts flow and causes pump noise.*

**Minimize Suction Lift** – Suction lift refers to the pressure (negative pressure) on the suction (inlet) side of the pump. As the vertical distance from the pump inlet to water increases, the suction lift pressure also increases. The practical suction/intake pipe limit for any pump is 20 vertical feet to water at sea level (subtract 1 ft. for every 1000 ft. of elevation). Limiting the pipe length to 2 to 3 feet will allow the pump to run quietly and more reliably. Placing the pump downhill from the water source also helps to minimize suction lift.

**Intake Pipe** – Keep the intake pipe distances as short as possible. Do not use thin-wall hose or soft tubing on the pump's intake. It may collapse under suction and restrict the flow. Polyethylene pipe (black flexible Polypipe) can be prone to slight leakage at the fittings, ensure all connections are watertight.

Increase pipe size as the distance from the water source increases. Use pipe reducer fittings to adapt the pump's inlet or outlet to a larger pipe size where necessary.

The intake pipe must not be obstructed or restricted by undersized pipe, excessive suction lift, or a clogged filter. Excessive suction at the pump inlet causes cavitation (formation of vapor bubbles). A cavitating SunCentric will not pump any fluid.

Avoid humps in the intake line that can trap air pockets and block the flow.

Ensure the intake pipe is free of leaks.

**Foot Valve** – The foot valve is a valve installed at the water intake that allows water to flow in one direction only. It is required in any case where the pump is located higher than the low-water level in the source. Use a high quality spring-loaded foot valve to avoid loss of prime.

A Dankoff Solar Fine Intake Strainer Foot Valve (PN – 11044) is recommended. The strainer prevents debris from catching in the foot valve and causing loss of prime.

**Priming the Pump** – Priming a pump means filling its intake pipe completely with water. This must be done if the pump is mounted higher than the water source. A removable plug or ball valve (if frequent priming is expected), should be installed at the highest point in the intake plumbing. Prime the pump and intake line by pouring water into the opening until it is completely full. The foot valve keeps the pump primed by preventing water from back flowing into the water source.

The pump will create enough vacuum to Self-Prime to around 10 feet (less at high elevations), but only when it is in new condition and wet inside.

**Check Valve** – A check valve, which allows water to flow in only one direction, is required if there is more than 30 ft. of lift above the pump, or in any pressurized system. This allows the pump to start easier. It also prevents back-flow when changing filter cartridges. Ensure the valve is installed correctly (the arrow indicates the direction of water flow).

**Pipe Unions** – If rigid piping (copper or PVC) is directly plumbed to the pump, unions are required. Unions make pump replacement easy, without the need to cut and re-solder or re-glue the pipe.

**Float Switch** – A float switch is a mechanical device that opens or closes a contact depending on its orientation in the water. A float switch may be used if dropping water level is causing a dry run condition or in a storage tank, pond or cistern to turn the pump off when full.

- A Pump Down (Normally Open) switch closes the contacts when the water level is high. Typically a Pump Down switch is used with a pump controller to indicate the tank is full.
- A Pump Up (Normally Closed) switch opens the contacts when the tank is full. A Pump Up switch is wired in line with one power wire of the pump motor.

Most float switches are rated for 15 AMPS at 230 VAC, ensure your motor does not exceed the capacity of the switch.

**Freeze Protection** – Take every precaution to prevent the pump from freezing. The forged brass pump head will survive most light freezes, but a hard freeze may damage it. If the pump is insulated for freeze protection, keep the motor exposed to prevent overheating.

A Gate Valve and Drain Valve are not required but are highly recommended (see diagram) for convenience during system shut-down. The drain valve is a garden hose outlet which allows easy draining of the system. It also allows water delivery by hose to the house during installation or repairs to plumbing.

**Mounting the Pump** – The pump may be mounted horizontally or vertically. If mounted vertically, suspend from a rope and face the pump head downward. Rigid mounting is not required in most installations. Observe the pump and ensure that it does not overstress or loosen pipes as it starts. In non-battery systems, starting is gradual and the pump does not torque with the start. In a battery system, the pump will jerk slightly, but mounting it to a small wooden board is sufficient to stabilize it. Mounting the pump directly to a wall or wood floor will increase the noise.

### Pump and Pipe Positions -- Yes or No?

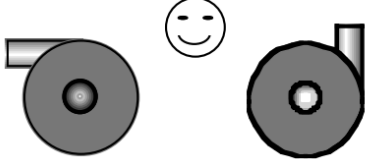
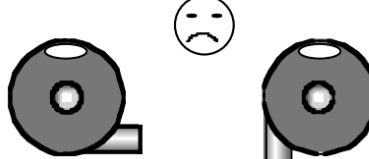
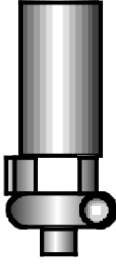
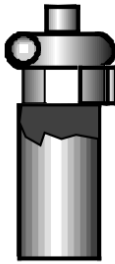
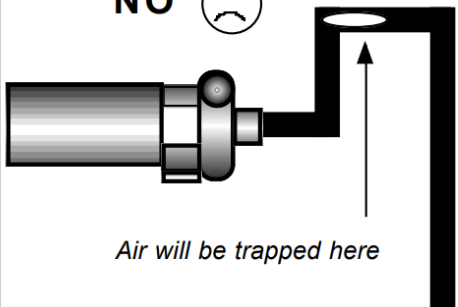
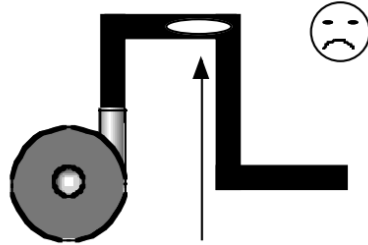
<p><b>YES</b> 😊</p>  <p><i>Air escapes from top of pump</i></p>	<p><b>NO</b> ☹️</p>  <p><i>Air will be trapped at top of pump</i></p>
<p><b>YES</b> 😊</p> <p><i>IF water source is higher than the pump's outlet</i></p>  <p><b>NO</b> ☹️</p> <p><i>IF water source is lower than the pump's outlet</i></p>	<p><b>NO</b> ☹️</p>  <p><i>Water leak will damage motor</i></p>
<p><b>INLET PIPE</b></p> <p><b>NO</b> ☹️</p>  <p><i>Air will be trapped here</i></p>	<p><b>OUTLET PIPE</b></p> <p><b>NO</b> ☹️</p>  <p><i>Air will be trapped here</i></p>

## 4. ELECTRICAL WIRING

Direct Current (DC) electric motors typically require far more current (amperage) than Alternating Current (AC) motors. The size of wire required to safely run a DC motor is determined by the length of the circuit run and maximum amperage draw of the DC motor on the pump.

### Warning!

**Under-sizing the wire to the motor can cause a Fire Hazard!**

On Dankoff Solar pumps the red wire is positive(+), black wire is negative(-), and green wire is ground.

Reversing polarity of the wires will cause reverse rotation of the motor. This will not cause damage if done for a short time. When facing the front of the pump, the pump shaft turns clockwise when polarity is correct.

### 4.1 WIRE SIZING

If the distance of the power circuit is longer than the factory installed wire, consult the chart below to find the correct gauge wire to splice onto the factory installed wire. Always use the Maximum Current Rating of the motor to determine wire size.

Figure 4-1: Wire Sizing Chart

Length (feet)	Current (amps)									
	5	10	15	20	25	30	40	50	60	70
15	16	12	10	10	8	8	6	6	4	4
20	14	12	10	8	8	6	6	4	4	4
25	14	10	8	8	6	6	4	4	2	2
30	12	10	8	6	6	4	4	2	2	2
40	12	8	6	6	4	4	2	2	1	1/0
50	10	8	6	4	4	2	2	1	1/0	1/0
60	10	6	6	4	2	2	1	1/0	2/0	2/0
70	10	6	4	2	2	2	1/0	2/0	2/0	3/0
80	8	6	4	2	2	1	1/0	2/0	3/0	3/0
90	8	4	4	2	1	1/0	2/0	3/0	3/0	4/0

**American Wire Gauge (AWG)**

*Example 1:* The motor is rated at 10 Amps maximum current draw and the solar panels are 30 feet away. The correct wire size is 10 gauge (10 AWG).

*Example 2:* The motor is rated at 7 Amps maximum current draw and the batteries are 50 feet away.

The correct wire size is 8 gauge (8 AWG). Always use the next higher rating on the chart if there is not an exact match for the motor amperage rating.

## 4.2 FUSE OR CIRCUIT BREAKER PROTECTION

### FAILURE TO INSTALL A FUSE OR CIRCUIT BREAKER WILL VOID THE WARRANTY

If water flow becomes blocked, or if the pump jams or freezes and cannot turn freely, the motor will draw excessive current. A fuse or circuit breaker opens the circuit before excessive current can damage the motor and wiring.

**Amp Rating** of fuse or breaker – Find the “Amp Rating” of the motor, then multiply that value by 1.35 (taken to the next standard value).

*Example 1:* The “Amp Rating” of the motor is 10 amps.  $10 \times 1.35 = 13.5$ . The next standard size fuse/breaker is 15 amps. Use a 15 amp fuse/breaker in this circuit.

*Example 2:* The “Amp Rating” of the motor is 2.7 amps.  $2.7 \times 1.35 = 3.6$ . The next standard size fuse/breaker is 5 amps. Use a 5 amp fuse/breaker in this circuit.

Install the fuse or breaker at the power source, to protect the wiring as well as the motor.

If the circuit is protected by a breaker, any additional fuse may be installed at the motor.

If a Linear Current Boosting controller is being used (Dankoff Solar LCB-100, for example) install the fuse/breaker between the current booster and the pump. Find the Max Amp rating of the LCB and the Max Amp rating of the motor and use the lower number as the Amp Rating of the fuse/breaker. This will protect the booster as well as the motor and wiring from overload.

**Fuses** – A circuit breaker is recommended over a fuse. If a fuse is used, A time-delay 3” fuse in a water resistant disconnect enclosure is the best choice. A disconnect provides fuse protection and acts as a shut-off switch for the pump. They are available from Dankoff Solar or may be purchased at any electric supplier.

An automotive in-line fuse holder may also be used on 12 or 24 VDC systems. Automotive blade fuses (type ATC) have sufficient time-delay and are preferred over glass fuses. Use good quality fuse holders protected from weather, and keep spare fuses handy. **NEVER SUBSTITUTE A LARGER FUSE!**

**Circuit Breakers** – Use a good quality DC breaker. AC breakers cannot be used for low voltage DC circuits. The SQUARE-D® QO or QB-series circuit breakers are safe up to 48 volts DC and are available in many amperage ratings. MidNight® Solar Inc. also has an extensive line of DC circuit breakers and enclosures and are available from retailers online.

## 4.3 GROUND AND LIGHTNING PROTECTION

Proper grounding will greatly reduce risk of lightning damage to the motor.

A proper grounded system consists of a minimum of one 8 ft. copper-plated ground rod driven into the ground, preferably in a moist spot close to the PV array. If available, a steel well casing is an excellent grounding point; drill and tap a bolt hole to make good electrical contact with it.

In a dry, lightning-prone location, use more than one ground rod at least 10 ft. apart. Bury bare copper wire between them. Use minimum #8 ground wire (larger for distances exceeding 20 ft).

In a rocky location, where ground rods can't be driven, bury 150 ft (total) of bare copper wire, radiating out in two or more directions from the PV array. Try to contact moist earth as much as possible. Use only copper or bronze electrical connectors designed for grounding application, and ensure all connections are well secured.

Connect the ground system to the frame of the PV array with 8 AWG copper wire. Also ground metallic support structures and electrical enclosures.

## 5. SOLAR ARRAY WIRING (FOR PV-DIRECT SYSTEMS)

**Warning** – The photovoltaic array generates hazardous voltages. A 48 Volt (nominal) array can generate nearly 100 volts when disconnected from load. All wiring **MUST** be done by qualified personnel, in compliance with local, state, and national electrical codes.

**To prevent shock hazard while working on array wiring, leave one wire disconnected between two modules to break the circuit, or cover array to shade it.**

**Attention** – Wiring the panels in the wrong configuration (series or parallel) can damage the controller and/or pump. Be certain of the wiring configuration (See Figure 5-1: Solar Panel Wiring Diagram for examples) prior to connecting the array. Additionally, it is recommended to cover or shade the panels when connecting them to the controller or pump. This prevents electrical discharge from damaging the equipment. Any damage caused by disregarding these warnings will **NOT** be covered under the warranty.

If the system uses only a single panel, simply connect the positive (+) and negative (-) wires from the panels to the pump or controller; however, if more power or voltage is needed to meet the pump requirements, multiple panels will have to be wired in either series, parallel, or series/parallel. Examples are provided below to better explain the differences between these configurations.

### Examples

For these examples, a common 195W (24V) Panel Rating – VMP: 38.16 VDC; VOC: 45.36 VDC; I: 5.10 amps will be used.

**Parallel** – Solar panels that are wired in parallel combine their wattage and their amperage, while the voltage remains the same. In the first example (2 Panels – Parallel) on Figure 5-1, the positive (+) ends of each panel are connected via a branch connector. The same is done for the negative (-) ends of each panel. Because this is wired in a parallel configuration, the voltage remains constant at 38 VDC (VMP or average up to 45.36 VDC open circuit), the watts are doubled to 390W (195W x 2), and a current of 10.20 amps (5.10 amps x 2) is present. Adding extra panels in parallel increase the amperage available (for higher pumping pressure) to the pump and increased hours of pumping time when compared to a single panel system.

**Series** – Solar panels that are wired in series combine their wattage and voltage, while the amperage remains constant. This is displayed in the second example (2 Panels – Series) on Figure 5-1. The positive (+) end of the first panel connects to the pump or controller, while the negative (-) connects to the positive (+) of the second panel. The second panel's negative (-) connects to the pump or controller, completing the circuit. Since this array is wired in series, the voltage doubles to 76 VDC (VMP or average up to 90.72 VDC open circuit), the watts double to 390W (195W x 2), and the current remains the same at 5.10 amps. The most common need for this configuration is to power a higher voltage motor.

**Series/Parallel** – The third example (4 Panels – Series/Parallel) on Figure 5-1 shows two parallel strings of two panels in series. Each string of two panels in series produces 76 VDC (VMP or average up to 90.72 VDC open circuit), 390W, and 5.10 amps. The two strings connected in series/ parallel produces 76 VDC (VMP or average up to 90.72 VDC open circuit), 780W, and 10.20 amps. This configuration is reserved for higher voltage pumps that require more current than a single string of solar panels wired in series can provide.

Solar Panels can be wired in a number of variations to produce the desired Watt/Voltage/Amperage configuration. Below are examples of the most common 2-4 panel wiring configurations, including panel arrays configured in series, parallel, and a combination of the two.

Figure 5-1: Solar Panel Wiring Diagram

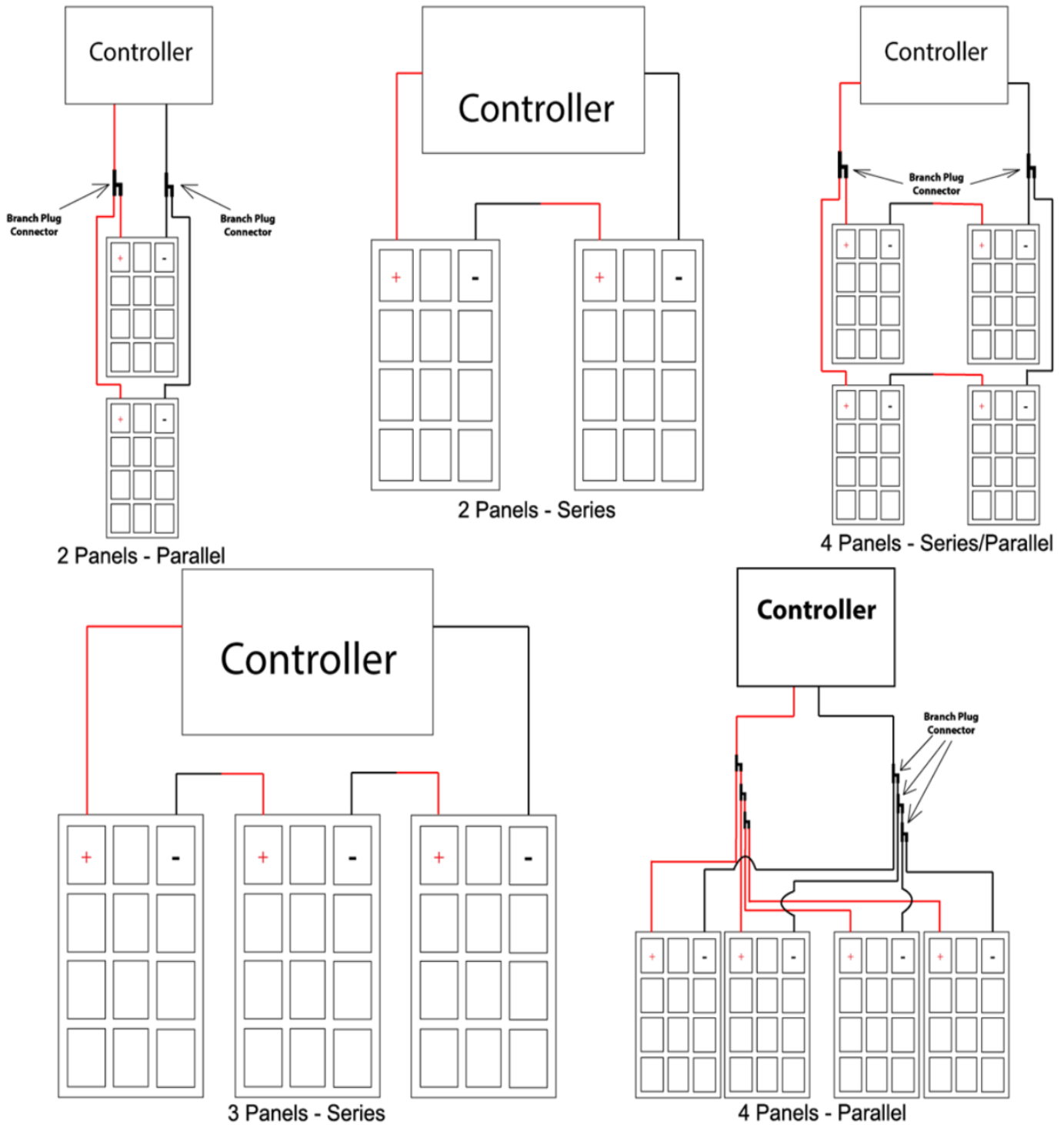

## 6. POWER CONTROL FOR PV-DIRECT (NON-BATTERY) OPERATION

When working against a constant head (vertical lift) pumps require constant current (amperes). In low light conditions the PV array cannot supply full current. The pump will load the solar array, voltage will drop to nearly zero and the pump will stall. A Pump Controller or Linear Current Booster is an electronic device that can greatly improve low light performance. It will match the power source to the load by transforming the voltage down while increasing the current delivered to the motor.

Contact Dankoff Solar or a dealer if the system doesn't have a controller or current booster

Figure 6-1: System Wiring for Typical PV-Direct SlowPump Installation

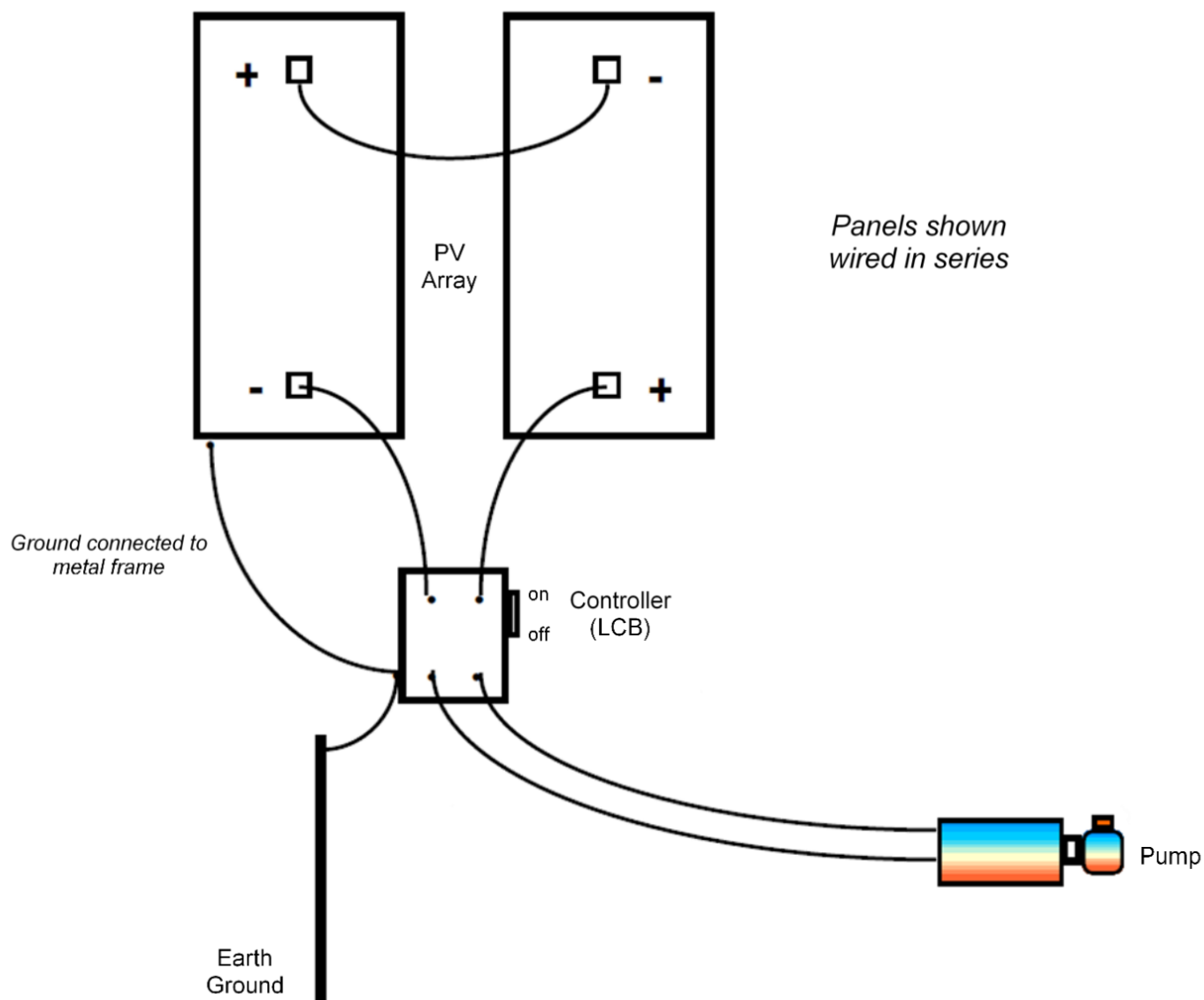

## 7. BATTERY SYSTEMS

SUNCENTRIC SURFACE PUMPS CAN RUN ON 12, 24, OR 48 VDC DIRECT FROM BATTERY or THROUGH A DC CONTROLLER AND OPERATE CORRECTLY.

Figure 7-1: Battery Charge Controller Wiring Diagram

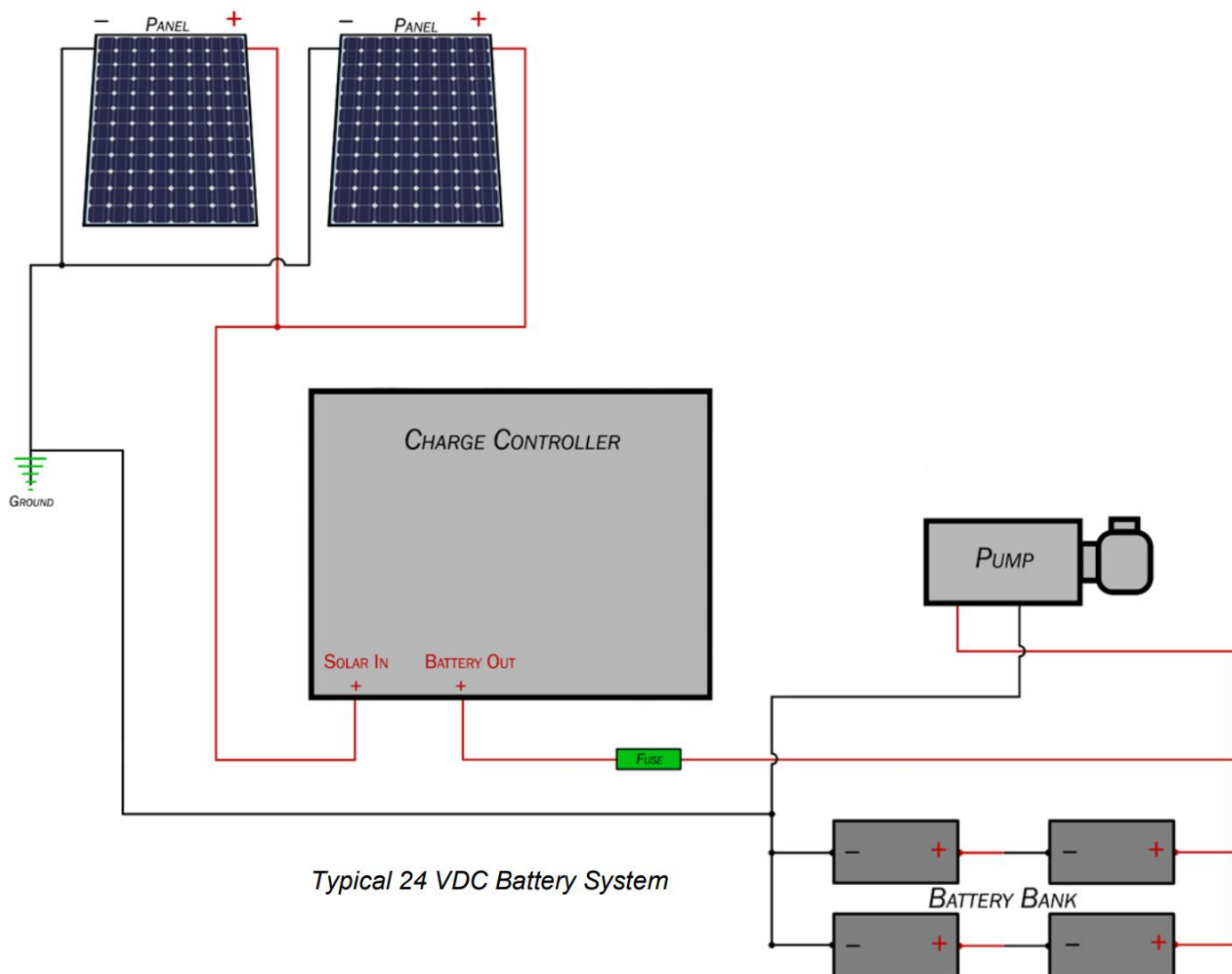

**Battery System** – The battery system voltage is determined by the motor voltage. A 12 volt motor requires a 12 volt battery bank; a 24 volt motor, a 24 volt battery bank, etc.

A battery's size (capacity in Amps) is measured in Amp Hours, the higher the Amp Hour Rating, the more amperage is available between charges.

The run time of the pump (when no sunlight is available) is directly proportional to the size of the battery or battery bank.

Adding more batteries to the battery bank or increasing the size of the batteries in the battery bank increases the overall amperage available and increases run time.

The charge time of the battery bank is determined by the amperage available from the solar array.

Large solar arrays with high current output will charge a battery bank to full charge at a much faster rate than small (or single panel) arrays.

The solar array must be sized large enough that, with the pump running at full capacity, the battery bank will still charge simultaneously.

The solar array must have a DC voltage output higher than the peak charge voltage of the battery bank (A typical 12 volt battery is fully charged when its voltage reaches 14.1 VDC).

Solar panels may be connected in series, parallel and series/parallel (see page 14) to increase voltage and amperage output.

The DC output from the solar array goes directly to a charge controller. The charge controller is an electronic device that regulates the correct voltage to the battery bank to ensure proper charging. It is sized to the array by voltage (12, 24 or 48 VDC are common), and amperage requirements. Charge controllers rated from 2 to 25 Amps DC output are common and large battery banks often have controllers capable of 60 Amp outputs or higher. The higher the current capability of the charge controller, the faster the recharge time of the battery bank.

Batteries may be connected in series and parallel (like solar panels) to achieve the desired voltage and amperage requirements of the pump.

A 12 VDC motor will typically use two or more 12 VDC batteries connected in parallel (positive to positive, negative to negative) to power the pump.

A 24 VDC motor (Figure 7-1) will typically use two 12 VDC batteries connected in series (positive to negative) to attain the required voltage. Two more batteries connected in series can be added in parallel to increase the battery banks storage capacity, and the pumps run.

**WHEN DESIGNING A BATTERY SYSTEM, ALL BATTERIES MUST BE OF THE SAME SIZE (AMP HOUR RATING) AND VOLTAGE.**

*Example 1: Correct* – Four 6 VDC, 120 AH batteries in series to produce 24 VDC.

*Example 2: Correct* – Two 12 VDC, 92 AH batteries in series to produce 24 VDC.

*Example 3: Incorrect* – One 12 VDC, 92 AH battery and two 6 VDC 120 AH batteries in series to produce 24 VDC.

## 8. TROUBLESHOOTING

**Pump Will Not Fit Into a 6" Casing** – Close Elbow fittings are required (PN – 20308).

### Motor Doesn't Turn On

1. Check Dry Run Switch on the front of pump, if present. Press red button to reset. Correct the cause of dry run.
2. Check fuse or breaker and any control or wiring devices in line.
3. Motor starts when hit or tapped lightly - Sticking brushes or other brush problem. Inspect the brushes.
4. Remove the rear cover of motor to check connections. Check for voltage present at motor. If voltage is present, see next entry.
5. Check Thermal Overload Switch on rear of the motor. Bypass it by holding a piece of insulated wire across the terminals. If the motor runs (and is not hot) replace thermal switch. The Dry Run Switch may be tested in the same manner.

### Pump Spins But Doesn't Pump Water

1. Check direction of rotation. If not clockwise (viewed from brass front-end) reverse motor polarity.
2. Check Prime - Open priming plug or valve and re-prime the pump. Check all the fittings, a pinhole leak in the suction pipe will cause loss of prime. Inspect, pressure-test, clean or replace the foot valve. Ensure no debris are trapped in the foot valve.
3. Polyethylene Pipe Fittings – Ensure fittings are tight. Gently heat with torch or hot water and retighten hose clamp with a wrench. Replace stripped clamps. Use stainless steel clamps.

**Noisy Pump** – A noisy pump indicates cavitation which can cause rapid pump wear.

**Unsteady buzzing sound** – Indicates leak in suction line allowing air to enter. Try the following:

1. Check for bubbles in inline (transparent) filter or air in outlet water.
2. Check prime. Open priming plug or valve and re-prime the pump. Check all the fittings, a pinhole leak in the suction pipe will cause loss of prime. Inspect, pressure-test, clean or replace the foot valve. Ensure no debris are trapped in the foot valve.
3. Some inline filters may have a red push-button valve to release pressure for maintenance. If the filter is incorrectly installed (too high above the water source) the suction may pull the valve open and introduce air. To prevent this, seal the push-button with silicone sealant or epoxy, or replace the button with a bolt and nut, sealed with silicon and tightened down.
4. If no source of air leakage is present, water may have high concentrations of dissolved gases which release as bubbles in the suction pipe. Reduce suction lift if possible. Install an air chamber in the intake line, with a valve on top. Pour water in to replace air when problem reappears.
5. Turning the filter to a horizontal position will move the bubbles out of the flow path of the water. Do not turn the filter upside down, as this could induce dirt into the pump during filter change.

### Filter clogs frequently

1. Intake too close to the bottom of well, stream, tank etc. Raise it as high as practical to reduce intake of dirt.
2. Improve the development of the water source. Channel clean water into a settling tank and clean the tank periodically.
3. Install a larger filter or plumb two filters parallel to each other.

**Low Flow Rate / Pump Turns Fast and Draws Low Current** – Pump is worn out from dirt, rust or other abrasive particles in water, or from cavitation, from running dry or age. Replace pump head.

### **Low Flow Rate / Pump Turns Slowly and Draws High Current (may run hot and/or blow fuses) / Pump is Difficult to Turn**

1. Excessive vertical lift, beyond the system's capacity: Exchange the pump head for a model with correct lift specifications or increase the size of solar array.
2. Misalignment of coupling shaft - Check rubber shaft coupler for damage.
3. Mineral Deposits - Turn shaft with two fingers. If difficult to turn, use vinegar to dissolve the mineral deposits in the plumbing. Remove pipes from the pump and allow solution to circulate through the pump by turning it backwards. Replace or rebuild the pump if deposits cannot be removed.

### **Low Flow Rate / Pump turns Slow, Motor Cool**

1. Voltage at motor measures lower than voltage at source. Power wire is undersized. Consult wire size chart.
2. See next entry.

### **Pump Runs Slow or Stalls in Low Light (Array-Direct, Non-Battery System)**

1. Solar array or wire is undersized.
2. Linear Current Booster or controller needed to prevent stalling when array current is less than pump requires. Contact dealer or Dankoff Solar.
3. Current booster not adjusted properly (if it has an adjustment). Set for peak performance in low light conditions. See current booster instructions.

### **Pump Will Not Turn** – The shaft coupler can't be turned by hand. The fuse is blowing or breaker is tripping.

1. After a period of disuse or storage, the impeller may lock up. Using pliers on the shaft coupler, gently rotate the pump backwards (counterclockwise).
2. Debris is jammed in the pump. Disconnect the plumbing, pour water into outlet, and run pump in reverse (by reversing polarity). Watch for debris exiting inlet. Damage to the pump is likely.

### **Pump Emits Crunching Sounds, Black Material in Outlet** – Internal parts are broken, either by debris in pump, severe freezing or external shock.

### **Water Damage, Motor Submerged or Dripped On** – Inspect brushes and commutator. If in poor condition, the motor may need a rebuild (new bearings). In extreme cases the motor must be replaced. Contact Dankoff Solar support. Correct the cause of damage.

### **Rusty/Noisy Bearings**

1. Pump head - Steel ball bearings are visible at pump head shaft. Rust caused by water drip or submersion. Pump head must be rebuilt to replace the bearing.
2. Motor - Replace with double sealed "R8" bearing (front) and "R6" (rear). These are common bearings available from automotive or electric motor suppliers, or directly from Dankoff Solar. A puller tool or a press is needed for removal.

### **Pump Frozen by Low Temperature / Blown fuse or circuit breaker tripped** – Allow the pump to thaw. Observe performance. If the motor is damaged, replace or rebuild. Check all plumbing for damage and leaks and protect from future freezing.

### **Motor Brushes** – Motor brushes are carbon rods that make electrical contact with the spinning copper "commutator" on the motor shaft. The two brushes are accessible via the cover at the rear of motor. Brushes must be unbound and slide in and out freely, a spring pushes the brush in as it wears.

Brushes must be at least 3/8" long (longer on motor larger than 5" diameter). They generally last about 5 years when connected to a Linear Current Booster or Dankoff Solar DC Controller, 2-3 years when connected directly to a PV, unless the motor has been wet inside (see "WATER DAMAGE").

1. Worn Brushes – Replacement brush part numbers are located on the pump label. Call your dealer or Dankoff Solar for replacements.

2. Sticking Brushes - Inspect inside each brush holder with a flashlight. Clean if corroded or dirty. If brushes still don't slide in/out freely, very lightly sand the long sides of each brush.
3. Brush Springs Weak - If the spring looks discolored the motor may have overheated from a severe overload and lack of fuse protection. Replace the brushes. If the motor does not start, it must be replaced.
4. Broken Brush Holder - Replace the brush holder (contact Dankoff Solar).
5. Commutator - The commutator is visible through the brush holders. The commutator may be damaged by poor brush contact, overheating or water damage. The wear surface should be smooth, with a uniform brown color. Commutator damage may require resurfacing on a lathe. Contact Dankoff Solar to perform these repairs.

## 9. MAINTENANCE

**Shaft Seals** - Seals may last for a few years, but if the water contains abrasive silt, the seals will wear faster. Seals will be quickly ruined if the pump runs dry. You can purchase spare seals from your Dankoff Solar dealer and **MUST** be installed correctly. The smooth white ceramic face must face outward, away from the motor. The part with the spring presses over the shaft. The all-black end must contact the white ceramic face. The metal and rubber end faces away from the motor.

### Seal and Gasket Kits

If last digit of the pump model number is 1, 2, 3, or 4 – order Dankoff Solar item #37690

If last digit of the pump model number is 5 or 6 – order Dankoff Solar item #37691

### Seal and Gasket Kits for High Temperature pumps

If last digit of the pump model number is 1, 2, 3, or 4 – order Dankoff Solar item #37695

If last digit of the pump model number is 5 or 6 – order Dankoff Solar item #37696

The seal is an industry-standard pump seal for 5/8" shaft. In case of emergency, you may be able to obtain one from a local pump supplier or electrical repair shop. If the paper pump gasket is damaged, a new one can be cut from thick paper. Manila file folders works fine.

Before pressing the seal parts into place, use your finger to wipe a small amount of oil or grease onto the cast iron, rubber and shaft surfaces. This will make installation and service much easier. **DO NOT** get any lubricant onto the mating white and black faces of the seal. Always replace **BOTH** parts of the seal (the black part and the black & white part)

**Pump Head** – The pump head is maintenance-free. Do not remove its front plate or otherwise tamper with it. The pump head is not user repairable. It is easy to disassemble, but difficult to reassemble without special tools.

**Motor Brushes** – Motor Brushes: Typical brush life peak hours = working voltage X 800 / 3rd digit of model number. EXAMPLE: PV-Direct curve #60 is Model 7526 working at 30V. Typical brush life =  $30 \times 800 / 2 = 12,000$  peak hours. This represents about 5-8 years of service. Your result may differ. New Brushes measure 1.25 inches (31 cm) in length. You can measure wear after a period of time, to predict the brush life. Worn brushes will not effect performance, until they are worn to about 1/2 inch (1 cm.). At that point, to motor will stop as contact is broken. Replacement brushes may be obtained from your dealer or the factory.

**Motor Bearings** - Ball bearings in the motor are lubricated for life and do not require maintenance. If water enters the motor accidentally, it will damage the bearings. Replacement bearings can be obtained from your Dankoff Solar dealer. Purchase two bearings #6203Z.

## 10. PUMP REPAIRS

### FAILURES

Most failures involve the pump head seal, not the motor, and is indicated by a properly primed pump not able to maintain vacuum and move fluid.

The pump head seal is **user** serviceable, however it is delicate and difficult to re-assemble. Disassembly of the pump head will void the warranty. If the pump head seal has failed, it must be replaced with a new one or sent to Dankoff Solar to be rebuilt.

**WARRANTY CLAIMS** must include receipt to prove date of purchase.

### TO SHIP PUMP TO DANKOFF SOLAR FOR REPAIR:

Please contact your Dankoff Solar dealer to set up a repair and receive an RMA number

(505) 471-2491

FAX (580) 225-1120

Email: [support@dankoffsolarpumps.com](mailto:support@dankoffsolarpumps.com)

Have the MODEL & SERIAL NUMBERS available before initiating a return for repair.

### WARRANTY

Dankoff Solar products are warranted to be free from defects in material and workmanship for ONE (1) YEAR from date of purchase.

Failure to provide correct installation, operation, or care for the product, in accordance with instructions, will void the warranty.

Product liability, except where mandated by law, is limited to repair or replacement, at the manufacturer's discretion. No specific claim of merchantability shall be assumed or implied beyond what is printed on the manufacturer's printed literature. No liability shall exist from circumstances arising from the inability to use the product, or its inappropriateness for any specific purpose. It is the user's responsibility to determine the suitability of the product for any particular use.

In all cases, it shall be the responsibility of the customer to insure a safe installation in compliance with local, state and national electrical codes.

**ADDITIONAL DANKOFF SOLAR SURFACE PUMPS FOR LIFT AND PRESSURIZING:****SOLAR FORCE PISTON PUMP**

- 5-9 GPM to 230 FEET or to 100 PSI
- Extremely rugged and dirt-tolerant

**SOLAR SLOWPUMP**

- 0.5-6.2 GPM to 450 FEET
- Capable of pushing through miles of pipeline

**SOLAR FLOWLIGHT BOOSTER PUMP**

- 2.7-4.5 GPM to 100 FEET
- Provide city water pressure anywhere

**SOLARAM SURFACE PUMP**

- 3-9 GPM to 960 FEET
- Ask your Dankoff Solar dealer or go to

**SUBMERSIBLE PUMPS FOR SURFACE AND DEEP WATER LIFT AND PRESSURIZING:**

SunRotor® Submersible Pumps, a division of Solar Power and Pump Co.

[www.sunrotor.com](http://www.sunrotor.com)

Dankoff Solar and Sunrotor are divisions of Solar Power and Pump Co.

301 West 12th Street

Elk City, OK 73644

(580) 303-4904

(866) 246-7652

Fax (580) 225-1120

[www.solarpowerandpump.com](http://www.solarpowerandpump.com)

# 11. NOTES TO INSTALLERS

The pump pulls water in by suction. The inlet plumbing must offer an unobstructed flow. The pump will be noisy if intake is restricted or blocked, or intake pipe is undersized.

The pump tolerates no solid debris.

A disposable cartridge filter is required at the intake. Never run the pump without a filter.

Do not omit the intake screen. After first test run, check the screen and remove any debris.

See the *Universal Wire Sizing Chart* on page 9 for

will void the pump warranty.

The manual contains important maintenance information, and is the property of the pump owner. Ensure manual is delivered to pump owner after installation.

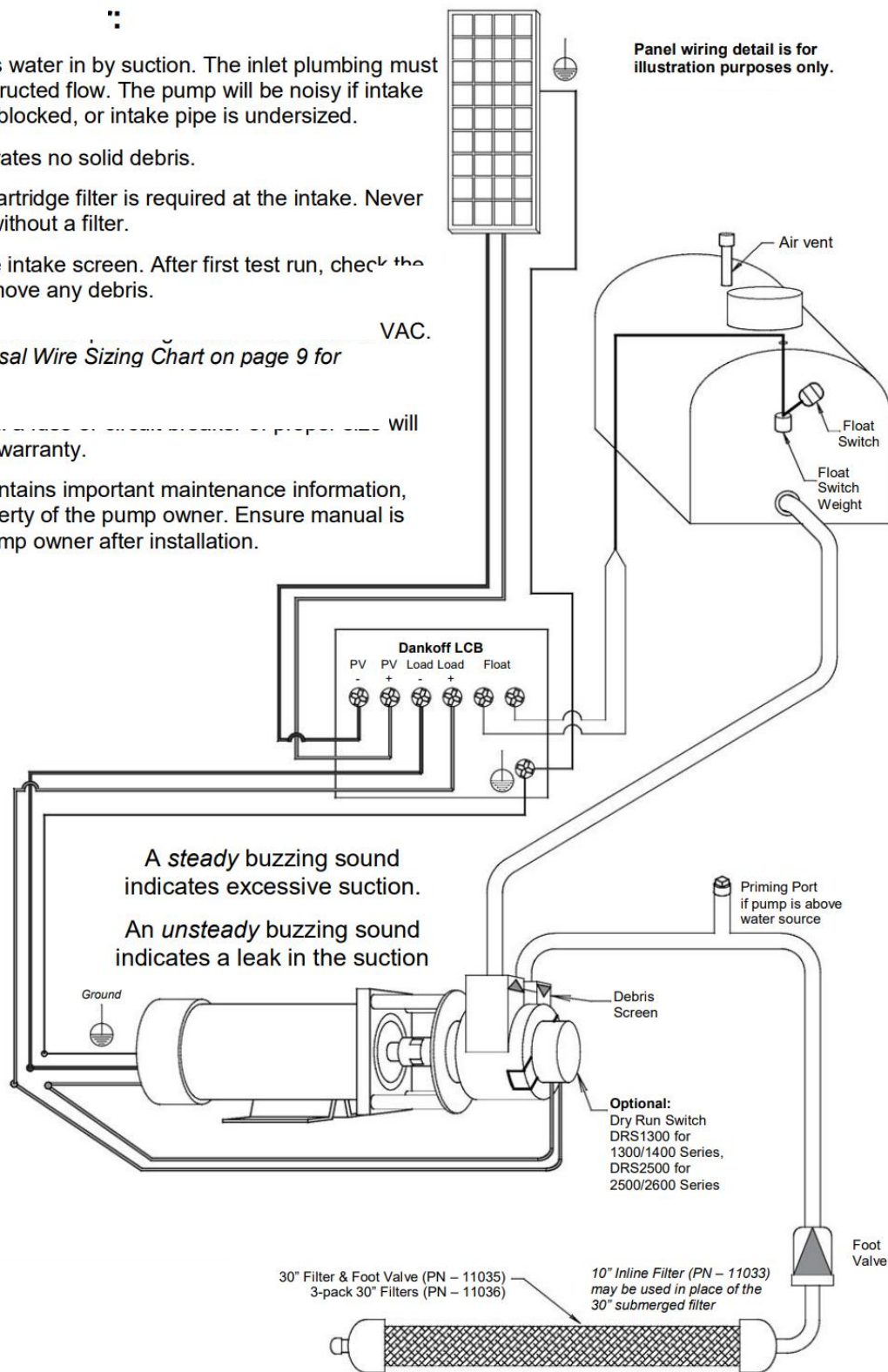

Panel wiring detail is for illustration purposes only.

A steady buzzing sound indicates excessive suction.  
An unsteady buzzing sound indicates a leak in the suction

30" Filter & Foot Valve (PN - 11035)  
3-pack 30" Filters (PN - 11036)  
10" Inline Filter (PN - 11033)  
may be used in place of the 30" submerged filter

**Dankoff Solar pumps are warranted to be free from defects in material and workmanship for TWO (2) YEARS from date of purchase.**

Failure to provide correct installation, operation, or maintenance for the product, in accordance with “Pump Installation and Service Manual” instructions, will void the warranty. Product liability, except where mandated by law, is limited to repair or replacement, at Dankoff Solar Pumps’ sole discretion.

No specific claim of merchantability shall be assumed or implied beyond what is printed on the Dankoff Solar Pumps’ printed literature. No liability shall exist from circumstances arising from the inability to use the product, or its inappropriateness for any specific purpose. It is the user’s responsibility to determine the suitability of the product for any particular use.

In all cases, it shall be the responsibility of the customer to ensure a safe installation in compliance with the Authority Having Jurisdiction (AHJ), whether that be local, state, or national electrical code.

Warranty does not cover damage due to sand or abrasive silt in the water, mishandling or other abusive conditions, failure to protect from weather exposure, failure to protect from overheating due to sun exposure, lightning, flood or other acts of nature.

For SlowPump and FlowLight Booster pumps, water must be filtered clean. Use of any filtration in a system utilizing a Solar SlowPump, other than what is offered by Dankoff Solar Pumps, will void warranty.

Motor brushes, shaft seals, diaphragms, and oil are considered to be normally wearing or consumed parts, and are not covered under warranty.

WARRANTY CLAIMS must be provided to Dankoff Solar by an Authorized Dankoff Solar Pumps Dealer/Reseller. Invoice from the authorized Dealer/Reseller, along with other documentation, required to prove date of purchase.

Dankoff Solar Pumps is not responsible for incidental or consequential damages, or the labor or other charges necessitated by the removal, transportation, or re-installation of any defective product.